

980884

1.

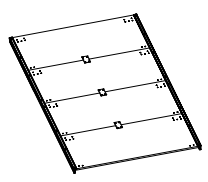

2.

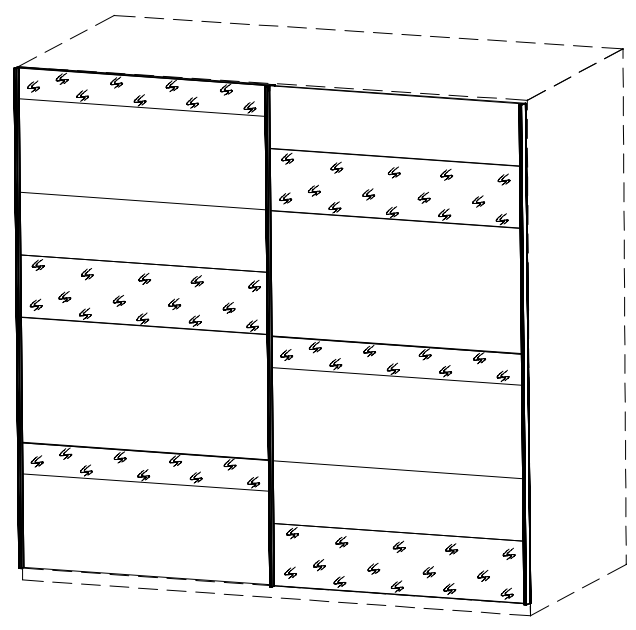
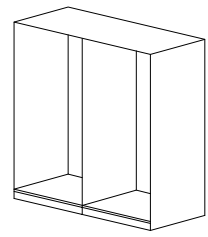
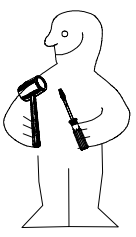

250-125-0

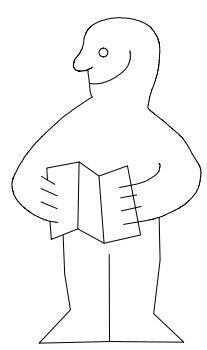
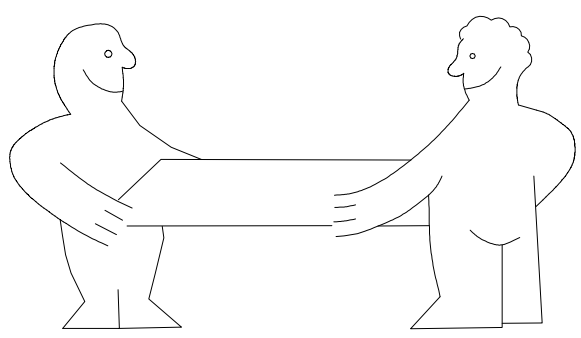
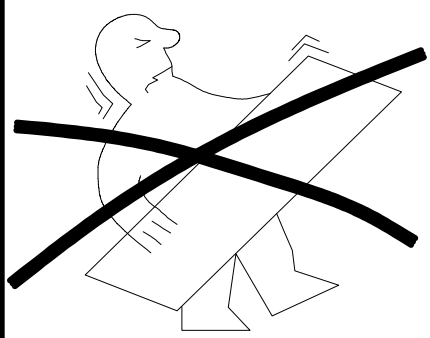

1-2-3-4... ○

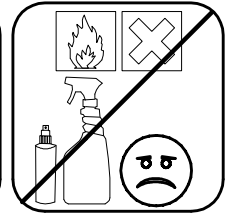
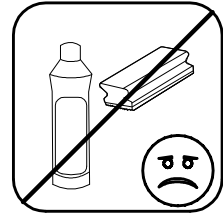
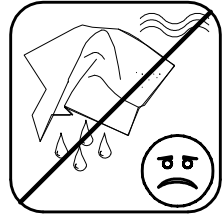
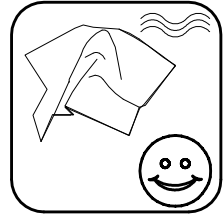
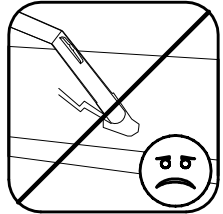
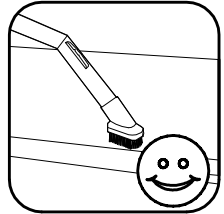
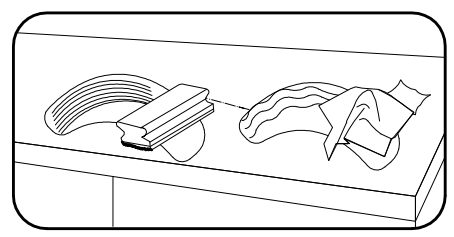
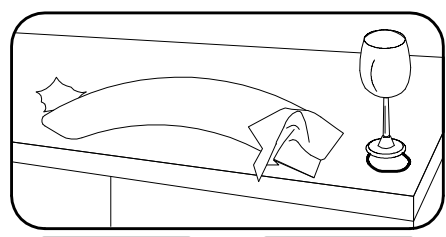
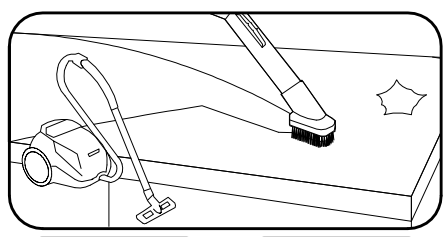
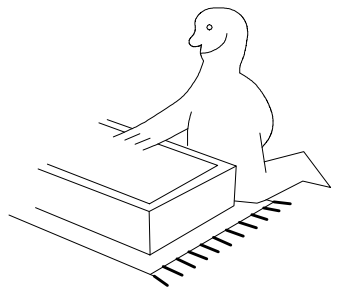
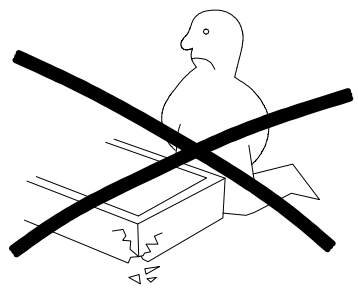
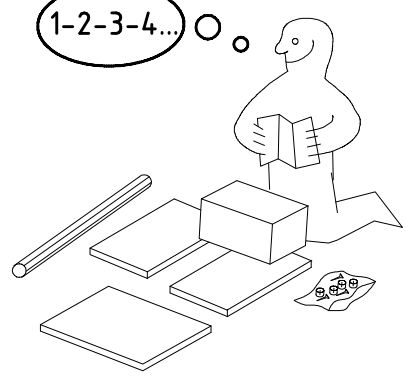

980884

26.11.12 / 03.10.15

10 15

1/4

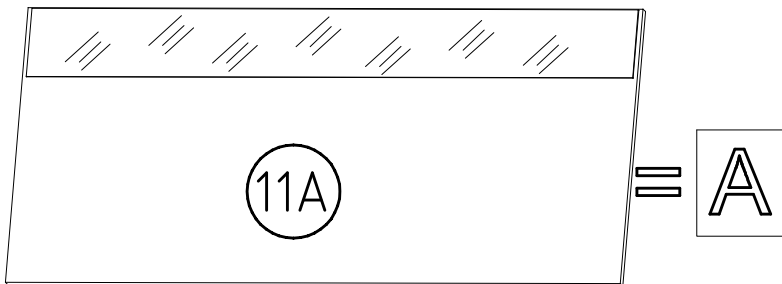
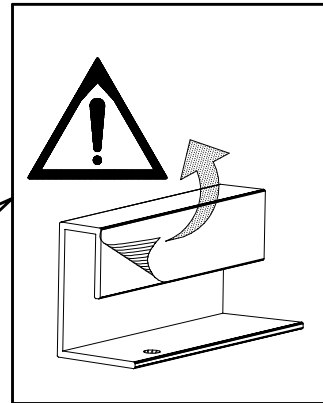
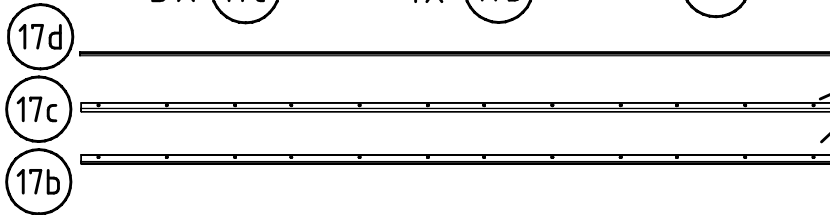
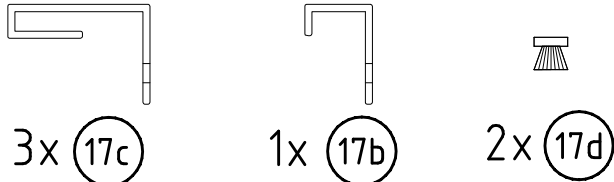
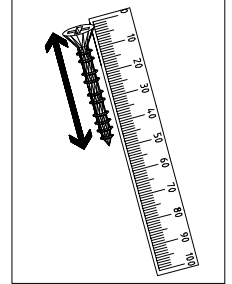
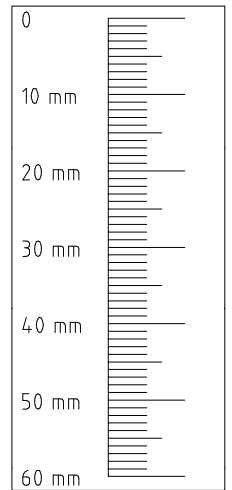
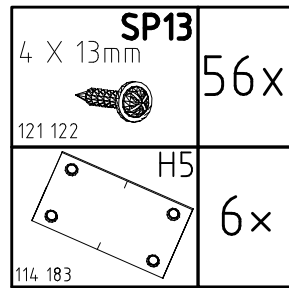
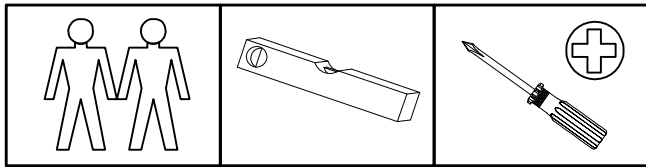

3x 695 / 916 / 1135 / 1357 / 1579 x 504 x 15

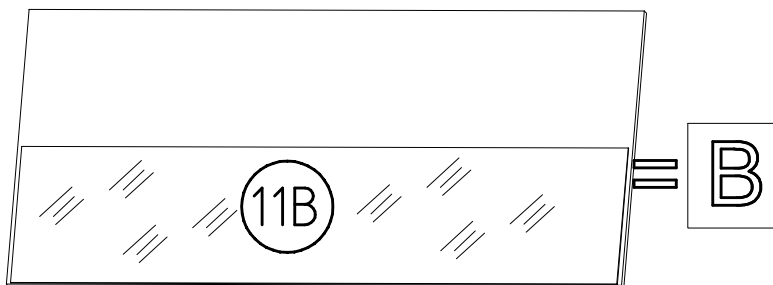

3x 695 / 916 / 1135 / 1357 / 1579 x 504 x 15

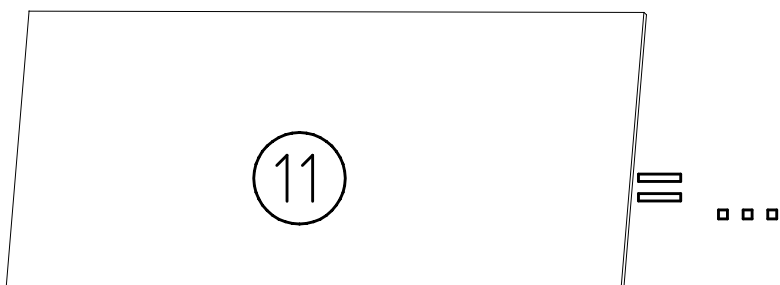

2x 695 / 916 / 1135 / 1357 / 1579 x 504 x 15

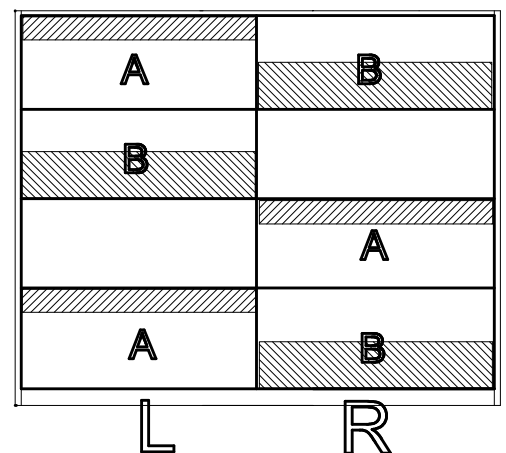
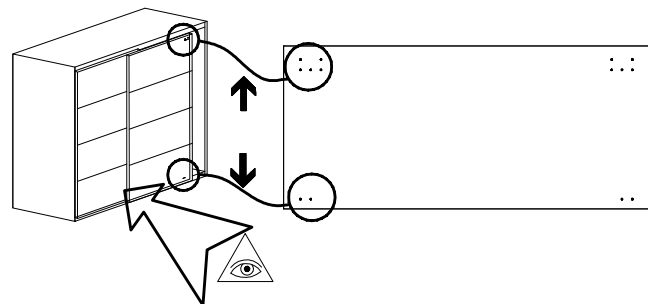

1

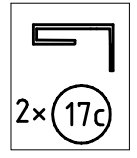
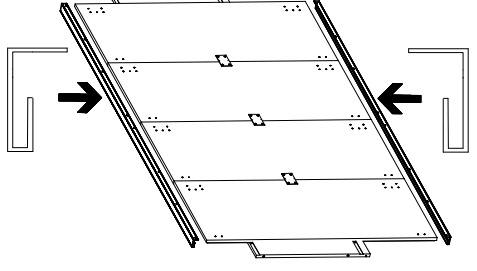
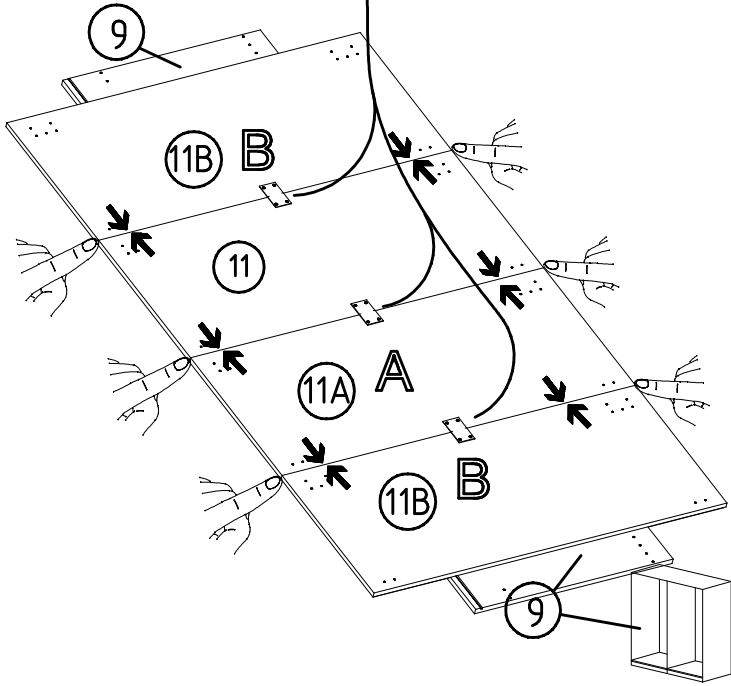
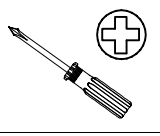
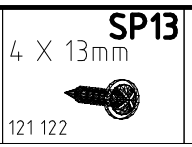
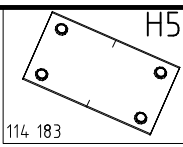
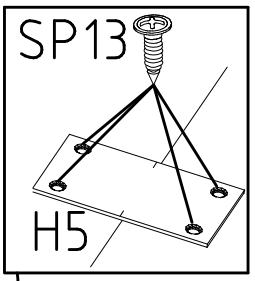
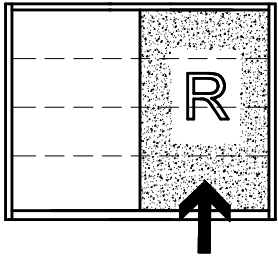

2

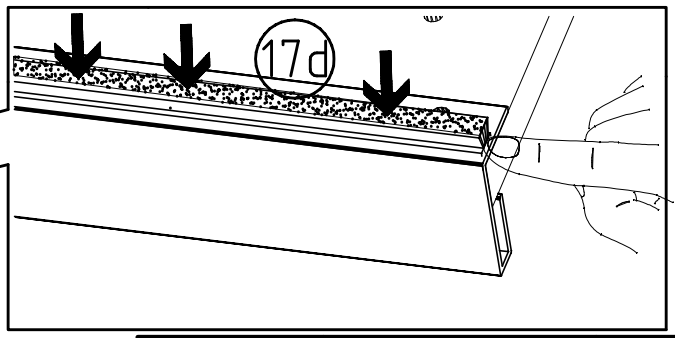
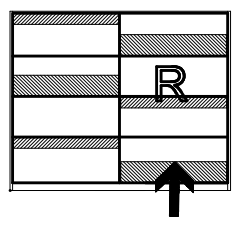
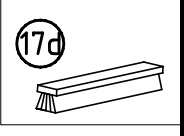
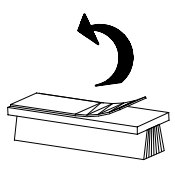
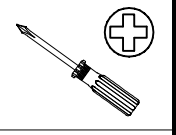
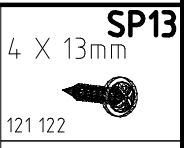
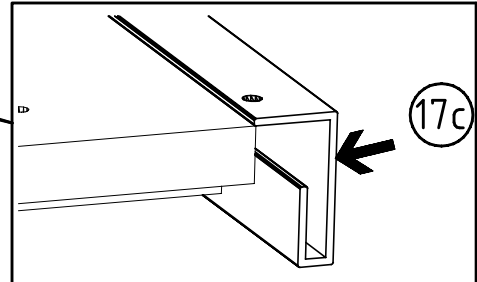
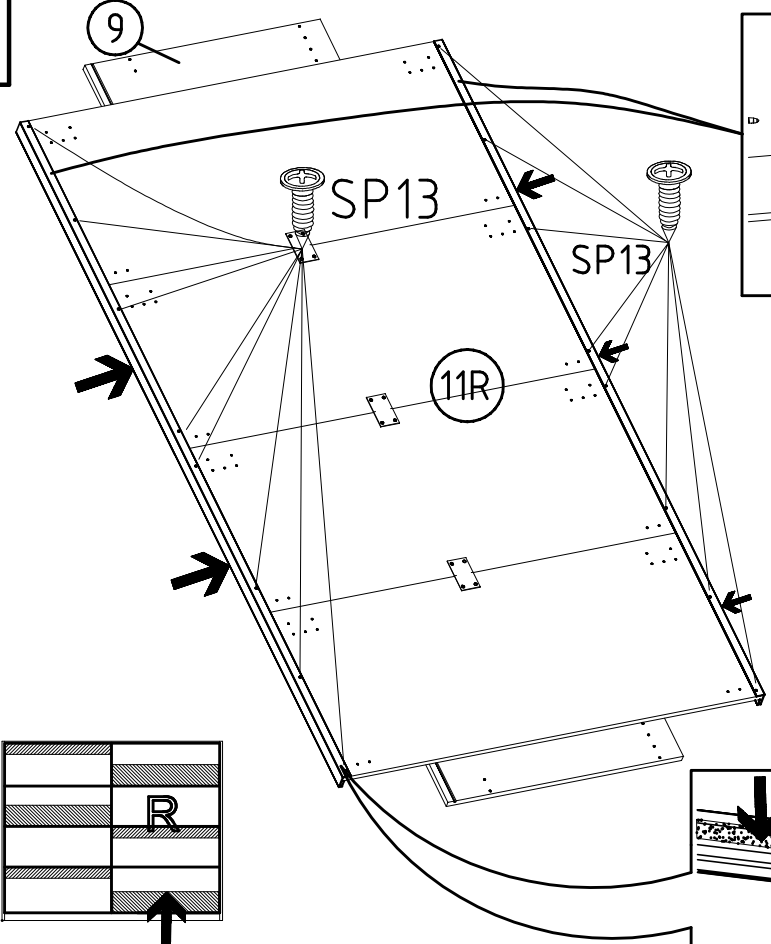

3

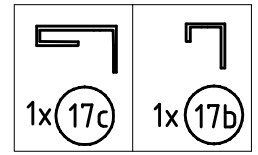
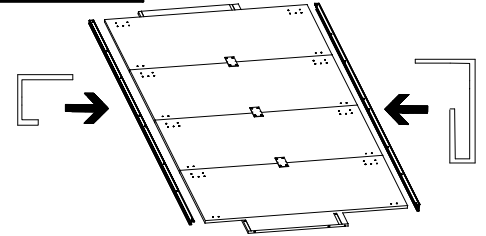
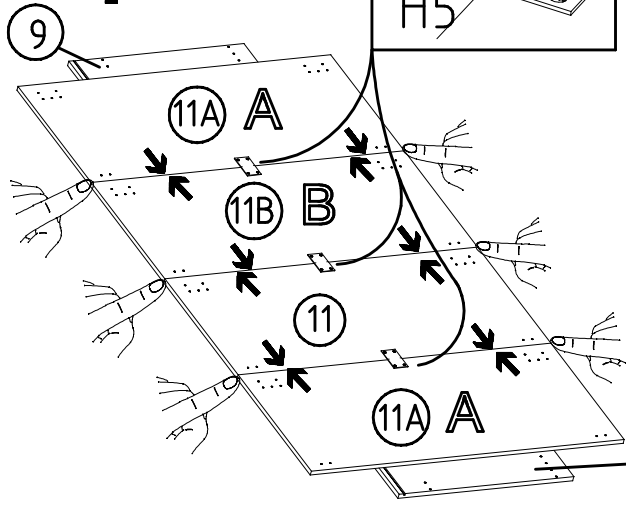
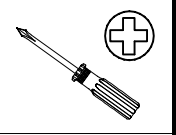
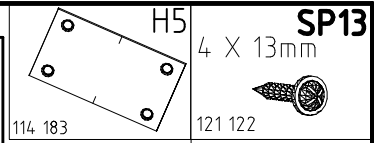
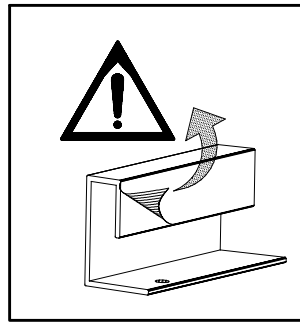
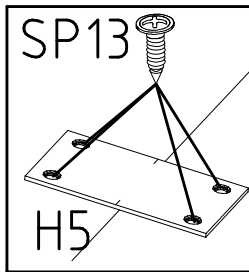
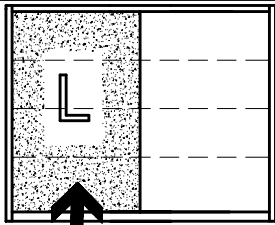

4

